

Durst M605

Operating manual

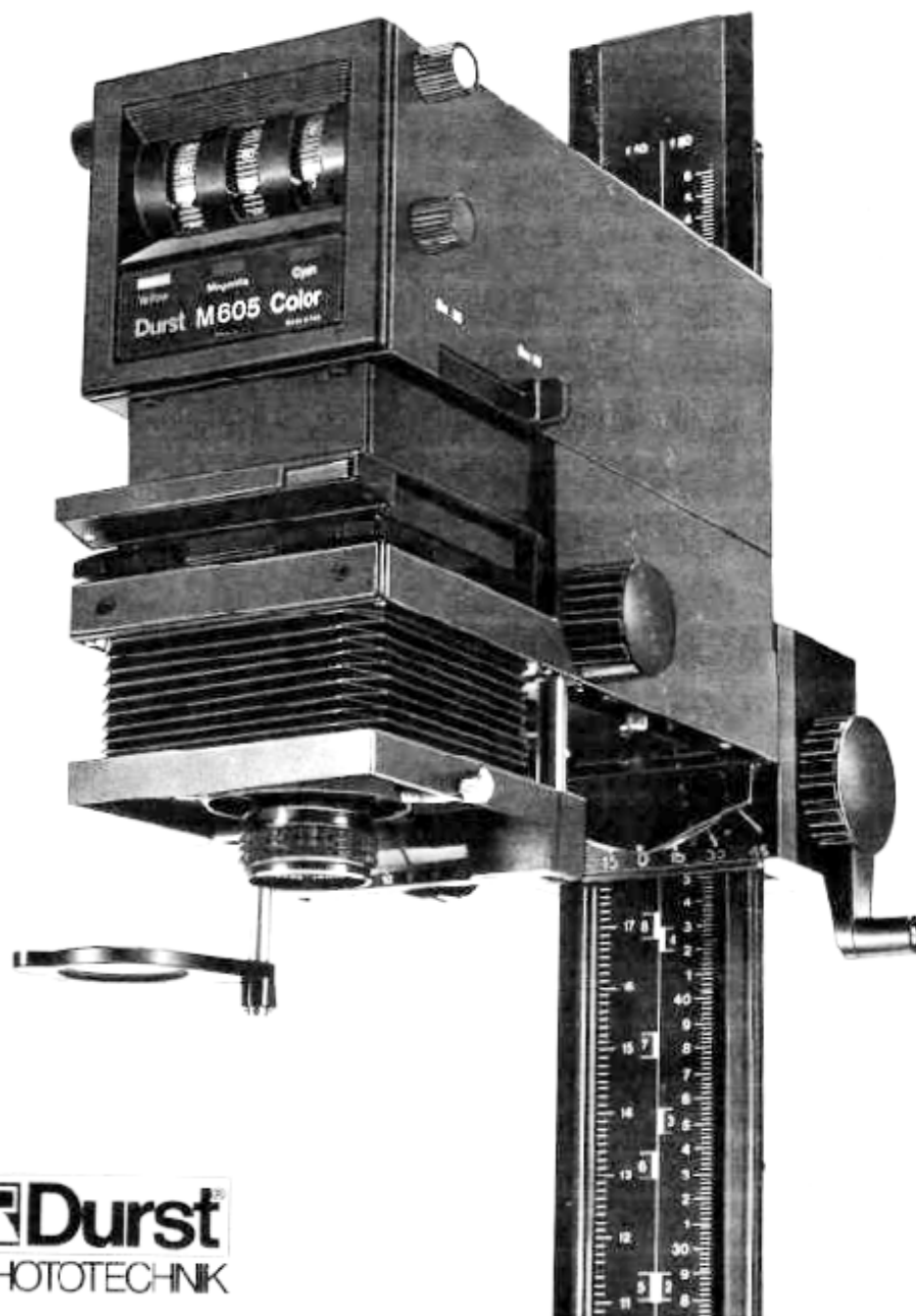

 **Durst**
PHOTOTECHNIK

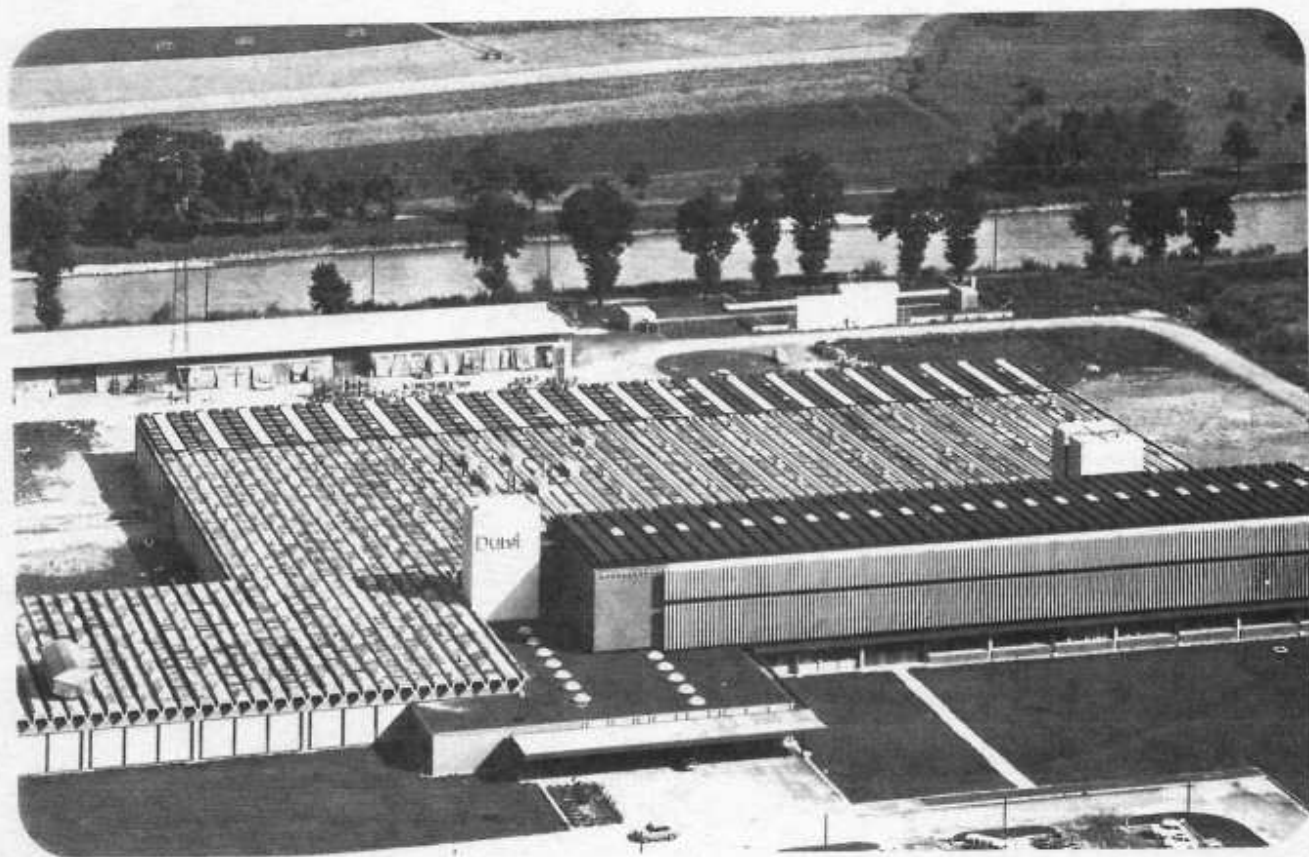

Addresses of the Durst Distributors

EUROPE

ANDORRA Tf: 21366
FOTO CINE COLOR
Avda. Meritxell, 66
ANDORRA LA VELLA

AUSTRIA Tf: 0222/465625
SAGA-FOTO mbH & Co. KG
Redtenbacherstrasse 82-84
1170 WIEN

BELGIUM Tf: 3844033
PROLUX S.p.r.l.
24, Chaussée de Nivelles
1420 Braine L'Alleud
BELGIQUE

DANMARK Tf: (01) 131397
E. JUL. HOTHER
Palaegade 5
1261 KOBENHAVN K

ENGLAND Tf: 01-4508070
EJMIG (UK) LTD,
14, Priestley Way
Eldonwall Trading Estate
LONDON NW2 7TN

FINLAND Tf: 6924101
MITRAS OY
Postfach 478
00101 HELSINKI 10

FRANCE Tf: 7311156
TELOS S.A.
72-76 rue Paul Vaillant
Couturier
F - 92300 LEVALLOIS PERRET

GERMANY Tf: 040/69221
DEUTSCHE DURST GMBH
Postfach 600580
Bramfelder Str. 102
2000 HAMBURG 60

GREECE Tf: 3235558
AGOPIAN SA,
Kolokotronistr. 11
ATHEN 125

IRELAND Tf: 984033
ILFORD (IRELAND) LTD,
Dundrum Castle, Dundrum
DUBLIN 14

ICELAND Tf: 85811
MATS WIBE LUND
Laugavegi 17B
P.O. Box 5211
125 REYKJAVIK

ITALY Tf: 490047/9
ERCA S.p.A.
Viale Certosa 49
20140 MILANO

NETHERLANDS Tf: 01725-9207
PROFIM foto/film b.v.
Industriepark 21 - Postbus 65
2420 AB NIEUWKOOP

NORWAY Tf: 02/133355
G. LUDVIGSEN A/S
Olav Ingstads vei 16
1351 RUD

PORTUGAL Tf: 401570
ALTINO PEREIRA LTDA
Rua Antero de Quental 153
4000 PORTO

SPAIN Tf: 2090311
GENERAL IMPORTADORA
FOTOGRAFICA
Calvet, 55-57
BARCELONA - 21

SWEDEN Tf: 08/71-09-940
MOLANDER & SON, AB,
Box 19
Ekholmsvägen 32
12721 SKARHOLMEN

SWITZERLAND Tf: 01/8300161
A.H. PETER AG
Birkenweg 2, Grindelstrasse
8304 WALLISELLEN/Zürich

AMERICA

ARGENTINE Tf: 35-8883
COLORTECNICA
S.C.I.F.I.A. y M.
Corrientes 1132 - 3er Piso
Oficina 31
BUENOS AIRES

BRAZIL Tf: (PABX) 67-1161
IMPORTECNICA S.A.
Caxua Postal 6134
SAO PAULO 01133

CANADA Tf: 759-9301
GENERAL PHOTOGR.
PROD. COMP.
1350, Birchmount Rd.
SCARBOROUGH / Ontario
M1P 2E4

CHILE Tf: 717651
IMPORTADORA FOTOGRAFICA
CHILENA LTDA.
Casilla 4200
Favor Velasco 16-A
SANTIAGO

COLOMBIA Tf: 245-3267
CINEFOTO
Ap. Aéreo 5285
Calle 39-A No. 14-48
BOGOTA - 1

MEXICO Tf: 589-13-25
CIA. IMPORTADORA
FOTOGRAFICA S.A. de C.V.
Av. Juarez 80
MEXICO 1, D.F.

PANAMA Tf: 62-1333
FOTO INTERNACIONAL S.A.
P.O. Box 1878
PANAMA 1

USA Tf: (602) 9671116
DURST NORTH AMERICA INC.
P.O. Box 3128
841, South Rockford Drive
TEMPE, Arizona 85281

VENEZUELA Tf: 218089
TONALITE S.A.
Apartado 3240
CARACAS 1010A

AFRICA

ALGIERS Tf: 650768
Société Nationale
Les Nouvelles Galeries
Algériennes
Direction Importation
Département Photo
67, rue Larbi Tebessi
BELCOURT

CANARY ISLANDS Tf: 247684-67
MAYA
P.O. Box 257
Calle Villalba Hervás 5
SANTA CRUZ DE TENERIFE

EGYPT Tf: 902671/890237
SOBHY ZAKY
147 (A) Ramsis Street
CAIRO

NIGERIA Tf: (01) 862597
BOLA OGUNS
PHOTOGRAPHIC
EQUIPMENTS LIMITED
36, Cemetery Street
P.M.B. 1069 EBUTE - METTA
LAGOS
Nigeria

SOUTH AFRICA Tf: 28-3020
FRANK & HIRSCH PTY, LTD.
P.O. Box 1893
JOHANNESBURG 2000

ASIA

ABOU DHABI Tf: 44643
SALAM STUDIO & STORES
P.O. Box 417
ABU DHABI

HONG KONG Tf: 5-540111
JEBSEN & CO. LTD.
(AGFA GEVAERT Dept.)
P.O. Box (Aberdeen) 4539
Scomber Building, 11th Floor
No. 1, Yip Fat Street
Wong Chuk Hang
HONG KONG

INDONESIA Tf: 593401-5
PT. INTER-DELTA
Postbag 3019/JKT
Jl. Let. Jen. S. Parman 78
(SRIH)

JAKARTA
JAPAN Tf: (3) 560-2051/9
ASAHI OPTICAL CO. Ltd.
Prof. & Ind. Prod. Sales Dept.
G.P.O. 895
TOKYO 100-81

KOREA Tf: 65-4741-6
DOOSAN INDUSTRIAL CO.,
LTD.
P.O. Box Kwangwhamoon 280
108-4, Susong-Dong
Chongro-ku
SEOUL

PHILIPPINES Tf: 406541
COLUMBIA TRADING
COMPANY
PHOTO SUPPLY
716, R. Hidalgo Street
QUIAPO, MANILA

SAUDI ARABIA Tf: 23070/22557
STUDIO SAMIR
P.O. Box 509
King Abdul Aziz Street
JEDDAH

SINGAPORE AND MALAYA Tf: 322055
M.H.E. CONSUMER (S)
Pte., Ltd.
1213, Supreme House,
12th Floor
Penang Road
P.O. Box 2162
SINGAPORE - 9

TAIWAN Tf: 364411
WING ZUNG CHONG, Co., Ltd.
N. 49, Section 1
Chung-Siao West Rd.
TAIPEI

THAILAND Tf: 2521161
BERLI JUCKER CO., LTD.
P.O. Box 173
542/1, Ploenchit Rd.
BANGKOK

AUSTRALIA

AUSTRALIA Tf: 9360400
HANIMEX Pty., Ltd.
108 Old Pittwater Road
BROOKVALE (Sydney)
N.S.W. 2100

NEW ZEALAND Tf: 448-146
HANIMEX (NZ) LTD.
P.O. Box 40-041
Poland Rd,
Glenfield
AUCKLAND 10

We are pleased that you have chosen a Durst M 605 enlarger. At the same time we thank you for the confidence you have shown thereby in our product.

With the Durst M 605 you have an enlarger made to Durst's strictest quality standards and fully up-to-date in design and engineering.

This instruction manual aims to familiarise you easily and clearly with the Durst M 605 and its two lighting systems. But it can fulfil this job only if you make full use of it. So take the time to study this manual thoroughly — it is worth your while.

Keep this instruction manual carefully for later reference or for more detailed information on specific questions.

We wish you much fun and success with your home enlarging.

Durst AG, Bolzano, Italy

Contents

1.0.0 General note

2.0.0 Assembly

- 2.1.0 Checking out
- 2.2.0 Components and operating controls
- 2.3.0 Assembling the basic unit
 - 2.3.1 The baseboard and column
 - 2.3.2 The enlarger head
 - 2.3.3 The negative carrier
 - 2.3.4 Lenses (not supplied)
 - 2.3.5 The red filter
- 2.4.0 Mounting the SIRIOKIT BW condenser lighting unit
 - 2.4.1 Condensers
 - 2.4.2 Removing the lamphouse cover
 - 2.4.3 Fitting the lamp (not supplied)
- 2.5.0 Mounting the CLS 605 colour mixing head
 - 2.5.1 Fitting the lamp in the colour mixing head
 - 2.5.2 Connecting the COLITRA 35 transformer and a timer

3.0.0 Features

- 3.1.0 Features of the basic unit
 - 3.1.1 The baseboard
 - 3.1.2 The column
 - 3.1.3 Vertical adjustment
 - 3.1.4 The negative carrier system
 - 3.1.5 Focusing
 - 3.1.6 Correcting converging verticals
 - 3.1.7 Lens panels
 - 3.1.8 Lenses
 - 3.1.9 The filter drawer
 - 3.1.10 Ventilation
 - 3.1.11 The red filter
- 3.2.0 Features of the SIRIOKIT BW condenser lighting unit
 - 3.2.1 Lighting system and light source
 - 3.2.2 Condensers
 - 3.2.3 Even illumination
- 3.3.0 Features of the CLS 605 colour mixing head
 - 3.3.1 Lighting system and light source
 - 3.3.2 Filter control
 - 3.3.3 Comparison tables of Durst, Kodak and Agfa filter values
 - 3.3.4 Supplementary filter
 - 3.3.5 Ultraviolet and heat filters
 - 3.3.6 The white light lever
 - 3.3.7 The mixing box
 - 3.3.8 The transformer

4.0.0 Operation

- 4.1.0 Clean negatives
- 4.2.0 Centering the lamp with the SIRIOKIT BW condenser lighting unit
- 4.3.0 Inserting film strips and single negatives
- 4.4.0 Setting the magnification
- 4.5.0 Focusing
- 4.6.0 Exposure
- 4.7.0 Cropping
- 4.8.0 Giant enlargements
- 4.9.0 Distortion control

5.0.0 Enlarging in colour and black-and-white

- 5.1.0 Colour enlargements
 - 5.1.1 Basic requirements
 - 5.1.2 Exposure and filter control
 - 5.1.3 Colour prints from transparencies
 - 5.1.4 Processing exposed colour prints
- 5.2.0 Black-and-white prints
- 5.3.0 Processing exposed black-and-white prints

6.0.0 Copying

7.0.0 Maintenance

1.0.0 General note

The Durst M 605 is a high-performance amateur enlarger for colour and black-and-white enlarging and copying; built to meet professional requirements.

The M 605 enlarges all negative sizes from 12×17 mm to 6×6 cm (2 1/4 × 2 1/4 inches).

This amateur enlarger is supplied to order either with the CLS 605 colour mixing head or with the SIRIOKIT BW condenser lighting unit.

This instruction manual provides detailed information on the basic M 605 enlarger, the CLS 605 colour mixing head and the SIRIOKIT BW condenser lighting unit.

2.0.0 Assembly

2.1.0 Checking out

The Durst M 605 is shipped in a special break-resistant packing. Depending on the unit ordered, the packing contains the colour version of the M 605 consisting of:

1. the basic unit
2. the colour mixing head
3. the tungsten-halogen lamp

or the condenser version of the M 605 for black-and-white enlargements, consisting of:

1. the basic unit
2. the condenser lighting unit
3. the opal lamp

Please check against the components list below that all parts are there. Separate sections of this list cover the basic M 605 unit, the SIRIOKIT BW condenser lighting unit and the CLS 605 colour mixing head.

To make the assembly instructions clearer, all components and operating controls are numbered. Before assembly carefully de-dust all components with a cloth.

2.2.0 Components and operating controls

Basic M 605 unit:

- 1) Baseboard
- 2) Column with column base
- 3) Bolts
- 4) Enlarger head
- 5) Locking knob
- 6) Carriage
- 7) Negative carrier
- 8) Opening lever of negative carrier
- 9) Lens panel
- 10) Lens carrier
- 11) Milled screw to secure lens panel
- 12) Red filter
- 13) Threaded hole for red filter shaft
- 14) Bellows
- 15) Lens standard rails
- 16) Locking key of negative carrier
- 17) Milled screws
- 18) Profile column
- 19) Cm scale
- 20) Inch scale
- 21) Magnification scale for 50 mm lens
- 22) Magnification scale for 80 mm lens
- 23) Knob for vertical adjustment
- 24) Extension arm (accessory)
- 25) Negative carrier masking strips

- 26) Bottom section of negative carrier
- 27) Negative carrier film stops
- 28) Focusing knob
- 29) Friction drive adjustment screw

SIRIOKIT BW condenser lighting unit:

- 30) SIRIOKIT BW condenser lamphouse
- 31) Condenser
- 32) Filter drawer
- 33) Milled screw for mounting condensers
- 34) Lamphouse cover latch
- 35) Lamphouse cover
- 36) Lamp holder
- 37) Copying window

CLS 605 colour mixing head:

- 38) CLS 605 colour mixing head
- 39) Lamphouse cover
- 40) Milled lamphouse cover screw
- 41) Retaining bracket
- 42) Scale wheels
- 43) Knob for supplementary filter
- 44) White light lever
- 45) Mixing box adjustment lever

2.3.0 Assembling the basic unit

2.3.1 The baseboard and column

Place the baseboard (1) with the rubber feet downwards on a table and locate the column base with column (2) over the holes in the baseboard so that the reinforcing ribs of the column base (2) face towards the rear. Place the backing plate in position and push the bolts (3) into the holes of the baseboard and column base from below. Screw tight with the hexagonal spanner supplied.

2.3.2 The enlarger head

Place the enlarger head (4) on the bearing shaft of the carriage and secure with the locking knob (5) at the left-

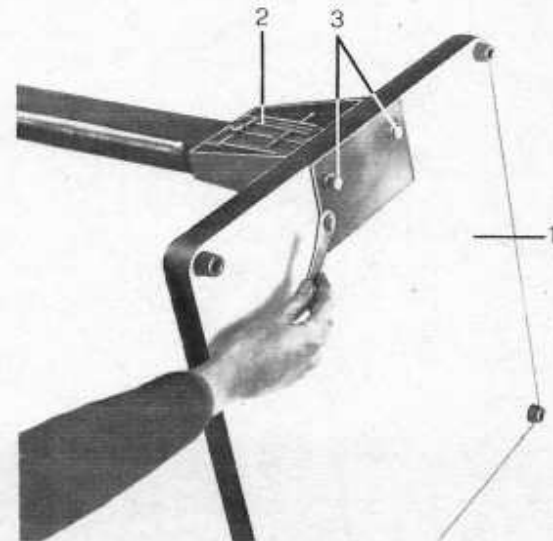

hand side of the unit. The catch of the enlarger head must engage the groove in the carriage shaft (6).

2.3.3 The negative carrier

Push the negative carrier (7), with the opening lever (8) on top, fully into the enlarger head.

Special note: When using the SIRIOKIT BW condenser lamphouse (30) do not insert the negative carrier into the enlarger head until the condenser lamphouse is mounted and the appropriate condenser (31) fitted.

2.3.4 Lenses

Fully screw the required lens (not supplied) into the appropriate lens panel (9). Then insert the lens panel together with the lens into the lens standard (10) and secure with the milled screw (11). Orient the lens so that the aperture scale is visible from the front.

2.3.5 The red filter

Although the red filter (12) is only used for black-and-white enlarging, it must also remain mounted for colour work to prevent light leakage through the opening (13).

To fit the red filter insert the red filter shaft into its hole in the lens standard and secure with the locking screw.

2.4.0 Mounting the SIRIOKIT BW condenser lighting unit

Fully retract the bellows (14) and fit the condenser lamphouse (30) over the two protruding rails (15) of the lens standard (10).

This ensures approximate centering of the holes in the condenser lamphouse over the holes in the enlarger head.

Now secure the condenser lamphouse to the enlarger head (4) with the two milled screws (17).

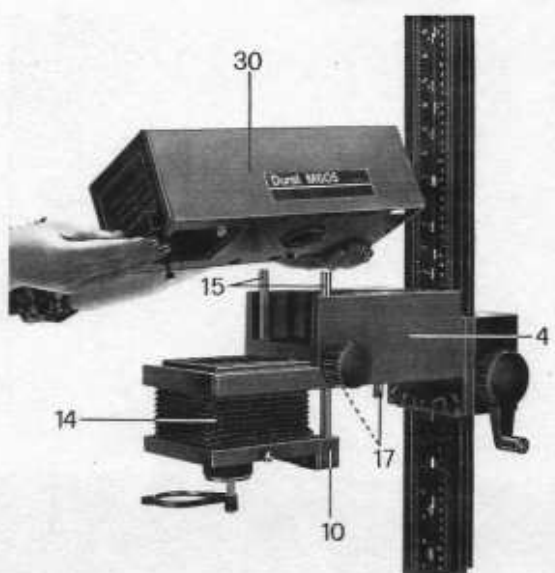
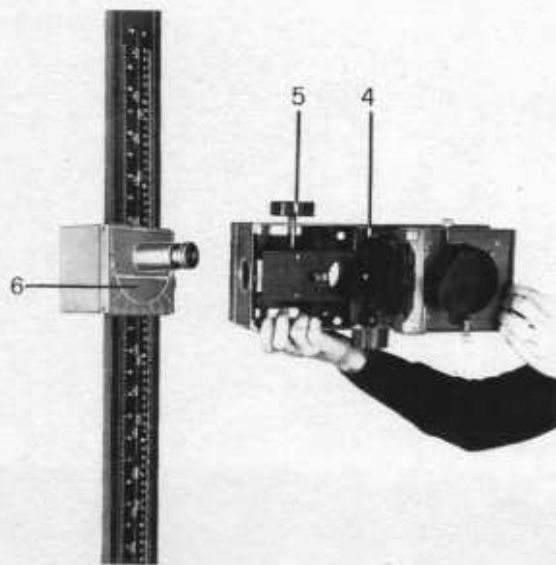
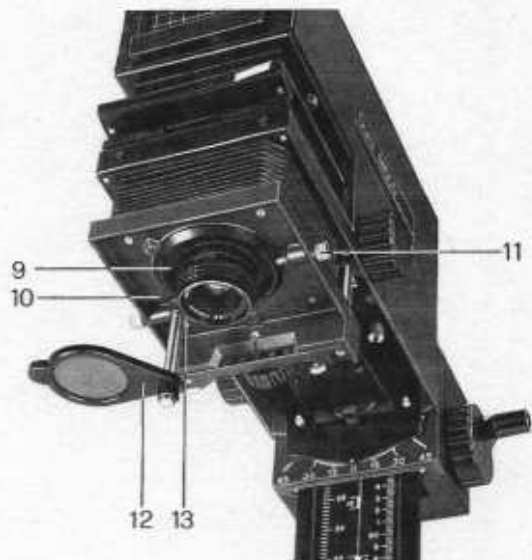
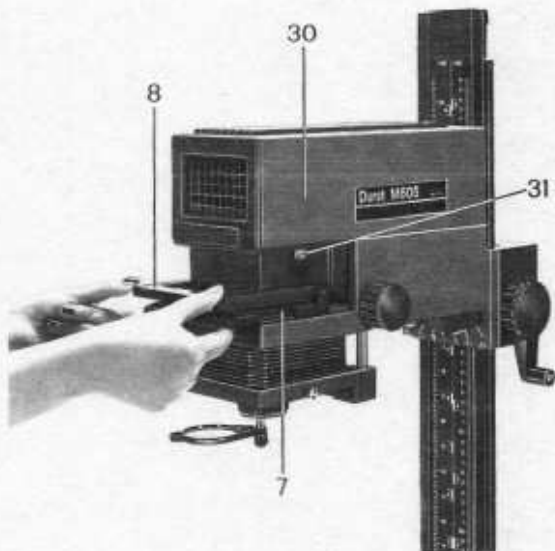

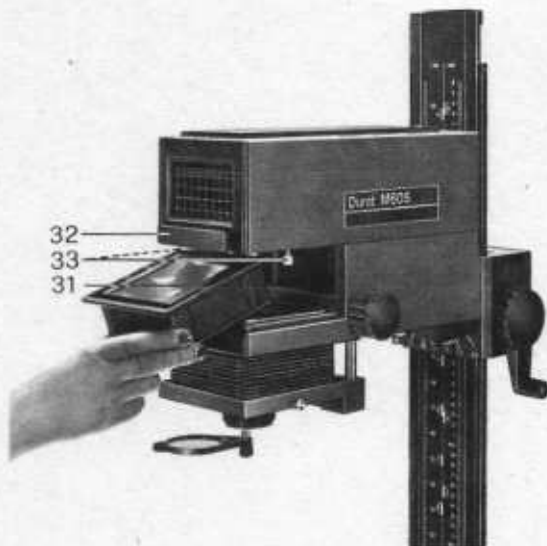

2.4.1 Condensers

Suspend the appropriate condenser required (31) directly below the filter drawer (32) by the milled screws (33) provided for the purpose. To do this, slack off the two milled screws, push the condenser with the two holes underneath the condenser lamphouse, push the condenser to the rear and secure with the milled screws (33).

When slacking off the milled screws note that they should not be unscrewed more than necessary to suspend the condenser from the condenser lamphouse. Otherwise it may not be possible to fit the condenser in the space between the enlarger head and condenser lamphouse.

2.4.2 Removing the lamphouse cover

Turn the red latch (34) to the left or right through half a turn and lift off the lamphouse cover (35).

2.4.3 Fitting to lamp

After removing the lamphouse cover push the lamp fitting (36) into the enlarger head from underneath and screw in the lamp supplied with the unit from above. Secure the lamp holder with the milled screw on the lamp carrier.

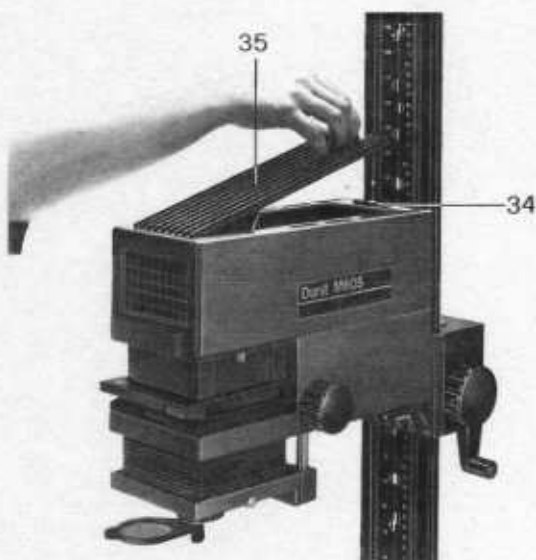

2.5.0 Mounting the CLS 605 colour mixing head

Move the bellows unit (14) fully to the top and place the colour mixing head (38) over the two protruding rails (15) of the lens standard (10). This approximately centres the holes of the colour mixing head over the holes of the enlarger head.

Now secure the colour mixing head to the enlarger head with the two milled screws (17).

2.5.1 Fitting the lamp in the colour mixing head

The lamphouse cover (39) is located in the underside of the colour mixing head. Unscrew the milled screw (40) to release the lamphouse cover from the colour mixing head. Two retaining brackets (41) are now visible inside and secure the tungsten-halogen lamp supplied with the unit.

Hold the tungsten-halogen lamp in one hand with the lamp axis horizontal and the protruding lug on the reflector pointing downwards. Now introduce the lamp in the lamp-

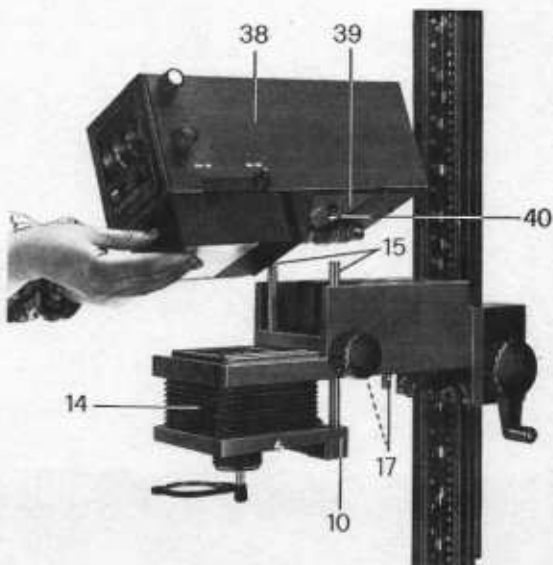
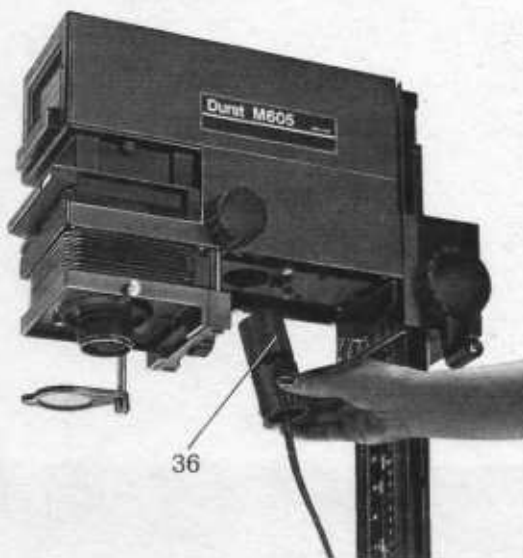

house and push in front of the two retaining brackets by pressing down on the reflector. The inner side of the reflector should not be touched. No centering is necessary. In order to have the lamp more easily inserted, push the mixing box adjustment lever (45) into its central position, i.e. between the 24×36 mm and 6×6 cm size indications.

2.5.2 Connecting the COLITRA 35 transformer and a timer
The Durst COLITRA 35 transformer is essential for all colour enlarging with the CLS 605 colour mixing head. Plug the lead of the CLS 605 colour mixing head into the transformer, the connecting lead of the transformer into the socket of the TIM 60 timer. Now the mains lead of the timer is plugged into the socket of the power supply.

3.0.0 Features

Durst enlargers and especially the Durst M 605 offer a wide range of features and advantages that appear in various details. Before dealing with operation, here is a description of some of these special product features.

3.1.0 Features of the basic unit

3.1.1 The baseboard

The Durst M 605 has a baseboard (1) for enlargements up to 40×50 cm or 16×20 inches without masking frame.

3.1.2 The column

The wide profile column (18) makes the enlarger particularly rigid. It carries cm (19) and inch (20) scales as well as magnification scales for the 50 mm (21) and 80 mm (22) lenses.

3.1.3 Vertical adjustment

The enlarger head is raised and lowered with the knob and crank (23) on the carriage.

A rack ensures precise adjustment. If the required magnification cannot be reached for part enlargements, mount the extension arm (24), available as an accessory, on the carriage shaft (6).

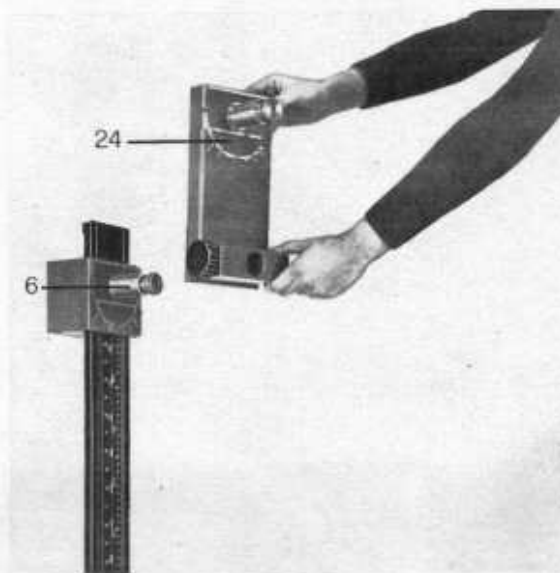
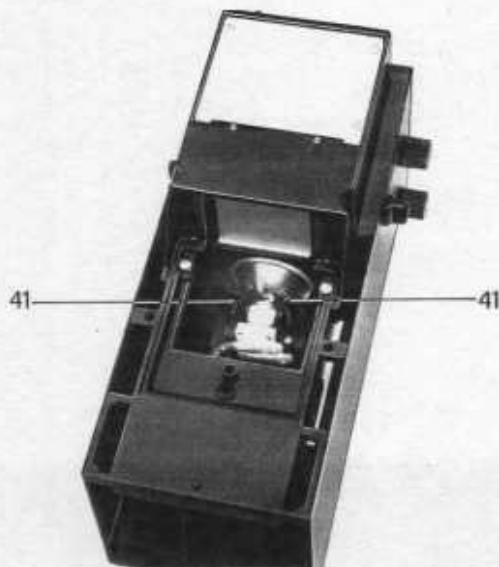
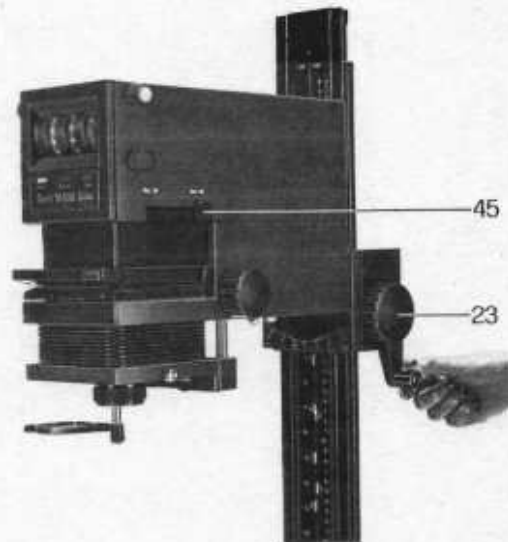
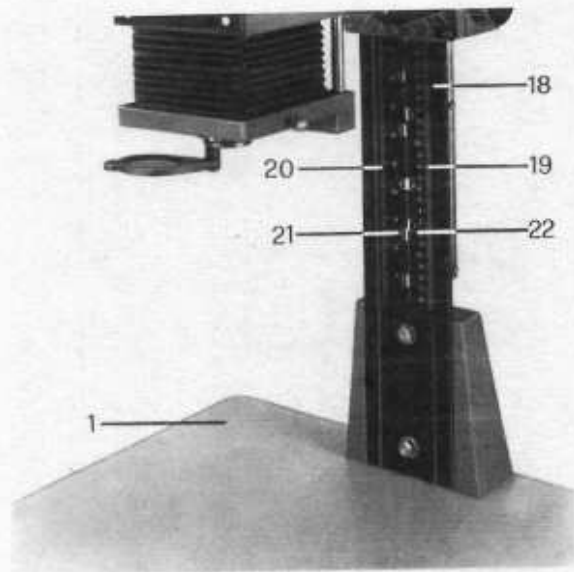

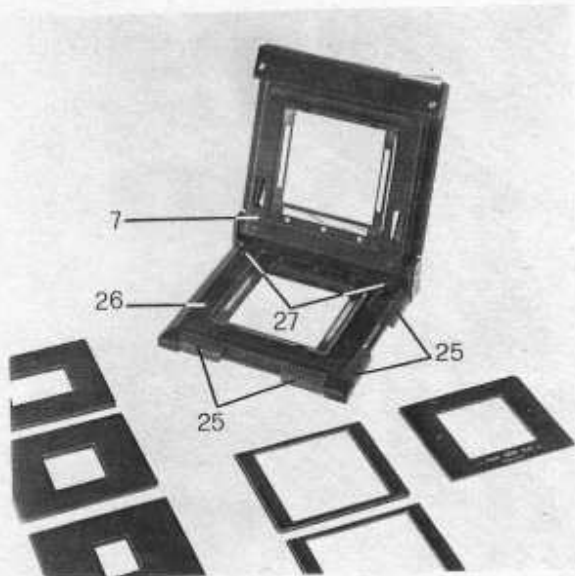

3.1.4 The negative carrier system

The basic outfit includes a hinged book-form negative carrier (7) for all negatives up to 6×6 cm or 2 1/4×2 1/4 inches. This carrier incorporates four individually adjustable masking strips (25) to crop the image. The bottom negative carrier section (26) has two adjustable film stops (27) for 6×6 cm and 24×36 mm films.

The negative carrier glasses hold negatives absolutely flat. A special coated negative carrier glass for preventing Newton's rings is available as an accessory. It's inserted into the negative carrier in place of the upper glass. The negative carrier glasses can also be replaced by glassless metal mask inserts. These inserts are available separately for the following formats:

- 6×6 cm (2 1/4×2 1/4 inches) — Code: SIVOPAR 66
- 4.5×6 cm (1 3/4×2 1/4 inches) — Code: SIVOPAR 45
- 24×36 mm — Code: SIVOPAR 35
- 26×26 mm — Code: SIVOPAR 26
- 18×24 mm — Code: SIVOPAR 18
- 12×17 mm — Code: SIVOPAR 17K
- 35 mm slide mask — Code: SIDIA

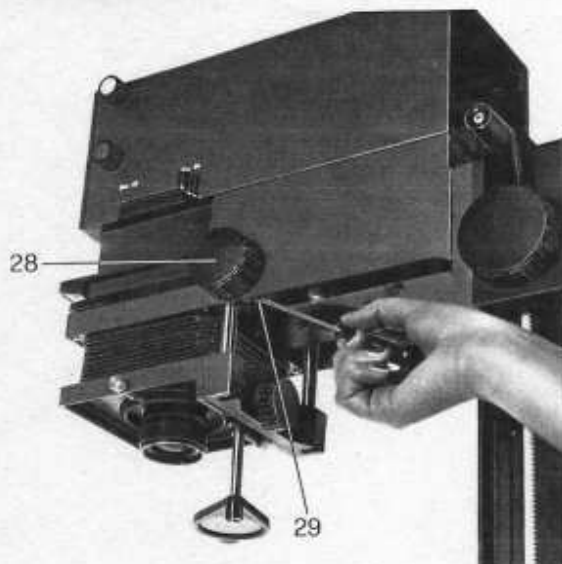

3.1.5 Focusing

The image is focused by raising or lowering the lens via the friction drive of the focusing knob (28). A small screw (29) permits adjustment of the friction.

3.1.6 Correcting converging verticals

You can correct converging verticals by tilting the enlarger head and raising the paper holder. Complete distortion control by the Scheimpflug system is also possible by tilting and horizontally displacing the lens carrier (10).

3.1.7 Lens panels

Two lens panels are supplied as part of the standard outfit of the Durst M 605: A flat panel (9) (order Code: SIRIOPLA) for the 80 mm and 75 mm lenses, and a recessed panel (9) (order Code: SIRIOTUB) for the 50 mm lens. Both have an M39×26 t.p.i. screw thread.

A lens panel for the 35 mm and 28 mm lens (again with M39×26 t.p.i. thread is obtainable separately (Code: LATUB K). For lenses with M25 thread a reducing ring (Code: FLARING) is used.

3.1.8 Lenses

Use only special enlarging lenses for making enlargements, as only such lenses are specifically corrected to the distance range used in enlarging.

Further be sure to use the correct lens for each film size. The appropriate lens for different negative sizes and the maximum print sizes obtainable on the baseboard are shown in the table below.

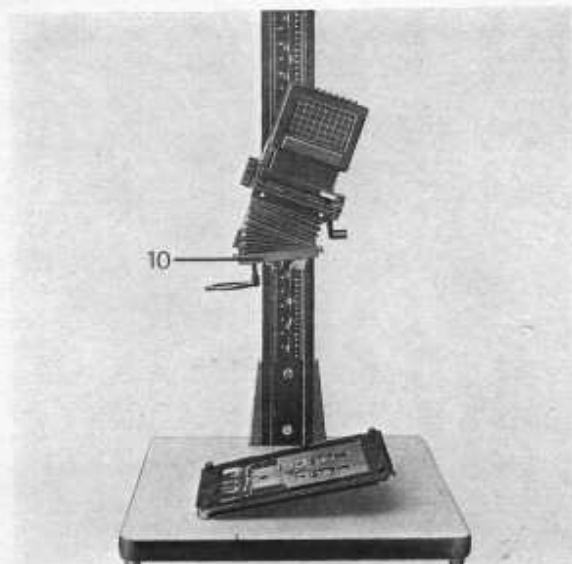

Focal length of lens	Negative size	Maximum enlargement on baseboard	
		Without extension arm	With extension arm
80 mm	6×6 cm (2 1/4×2 1/4")	30×40 cm (12×16")	50×60 cm (20×24")
75 mm	6×6 cm	30×40 cm	50×60 cm
50 mm	24×36 mm	30×40 cm	40×50 cm (16×20")
35 mm	18×24 mm	30×40 cm	40×50 cm
28 mm	12×17 mm	30×40 cm	40×50 cm

3.1.9 The filter drawer

The front of the M 605 condenser lighting unit carries a

filter drawer (32) to hold variable contrast and heat filters. The drawer takes 75x75 mm filters.

3.1.10 Ventilation

The double-walled condenser lamphouse carries slots along its edges for dispersal of the heat developed by the lamp. Hence there is no risk of overheating even during prolonged operation.

3.1.11 The red filter

The red filter (12) permits observation of the image with the enlarger switched on and the black-and-white enlarging paper in position.

3.2.0 Features of the SIRIOKIT BW condenser lighting unit

The basic enlarger can be ordered with the condenser lamphouse (30) for black-and-white enlargements or – if required – subsequently fitted with this condenser unit.

3.2.1 Lighting system and light source

The condenser lighting unit is fitted with a 150 watt opal lamp. This is available through photo dealers (Code: LAMP 150). Check the bulb regularly for dark deposits on the inside of the glass. If these become visible on projection, replace the lamp.

Like all Durst enlargers, the condenser unit of the Durst M 605 has a reflex lighting system.

A mirror set at 45° redirects the light from the opal lamp to the negative carrier. The advantage of this arrangement is that most of the heat passes through the reflector and does not reach the negative carrier.

3.2.2 Condensers

The condenser lamphouse is supplied complete with a single condenser and a double condenser. The double condenser SIRIOCON 80 (31) is mounted on the condenser lamphouse for use with 80 mm lenses, i.e. for enlargements from 6x6 cm or 2 1/4 x 2 1/4 inch negatives. When enlarging 35 mm films with 50 mm lenses replace the double condenser by the single SIRIOCON 50 (31) condenser.

3.2.3 Even illumination

The reflex lighting system with the condensers and opal lamps ensures exceptionally even illumination, provided the lamp is carefully centered before enlarging. (For centering see section 4.2.0.)

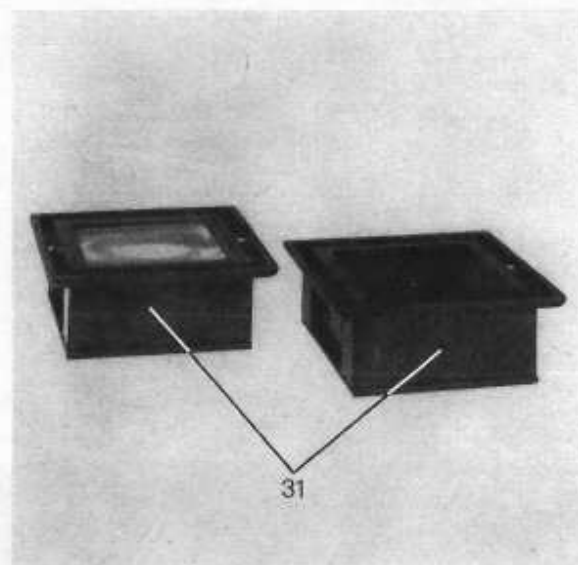
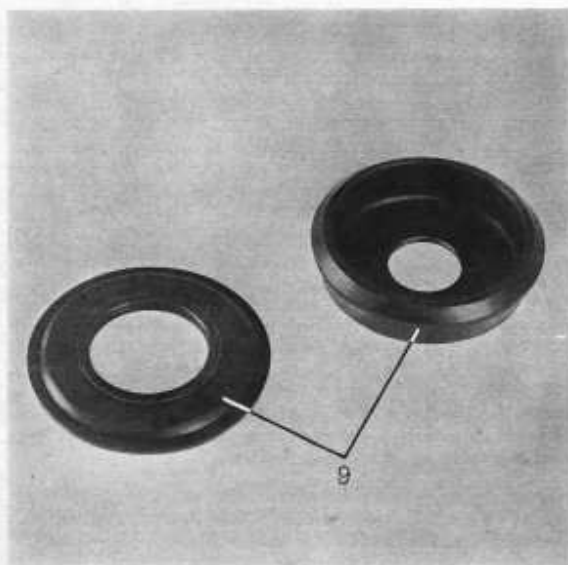
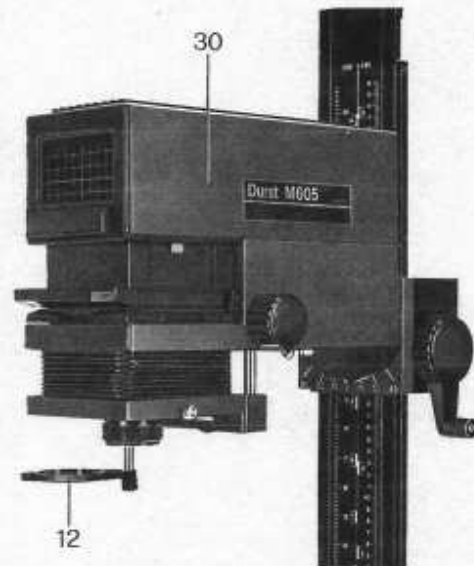
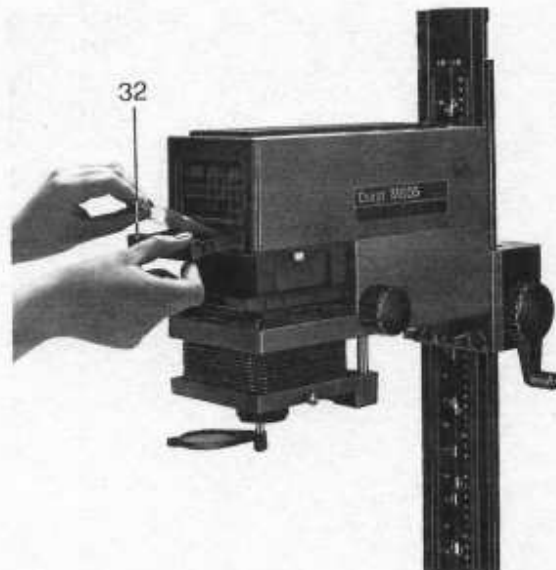

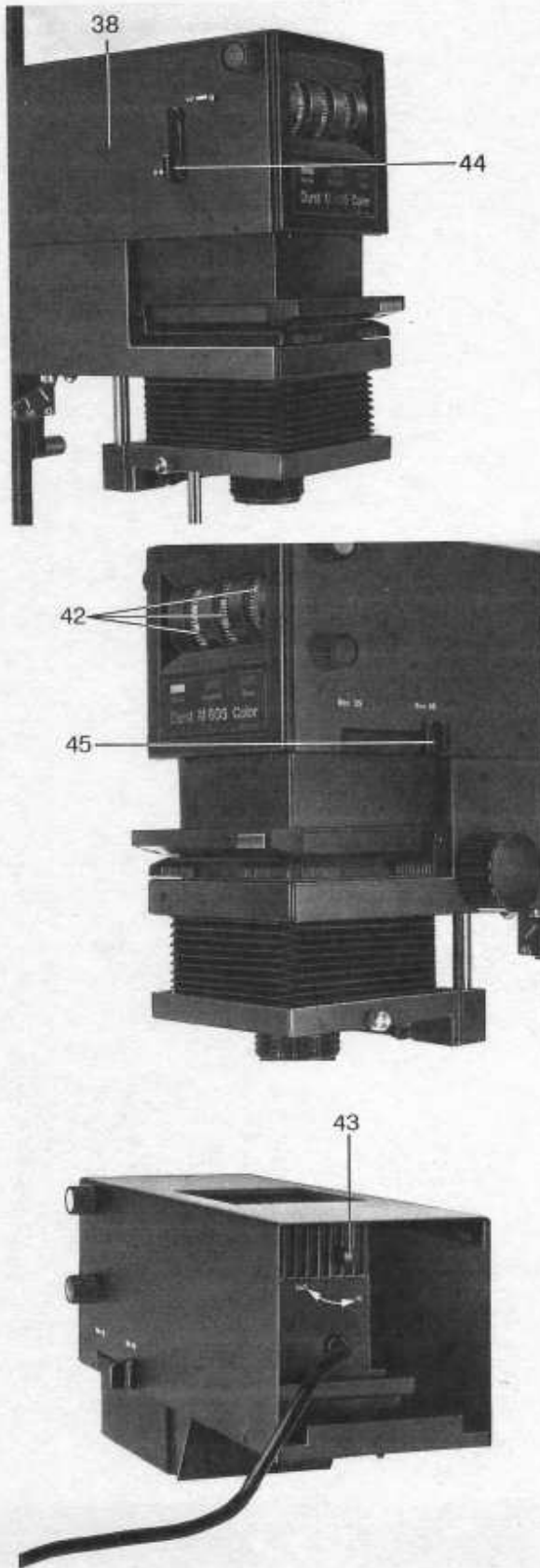

3.3.0 Features of the CLS 605 colour mixing head

The basic unit can be ordered complete with the CLS 605 colour mixing head (38) or subsequently equipped with this head.

3.3.1 Lighting system and light source

Like all Durst colour mixing heads the CLS 605 has a reflex lighting system for exceptionally uniform high-intensity illumination with low heat evolution. The 100 watt tungsten-halogen lamp used in the colour mixing head offers the following advantages especially for colour work:

1. Constant colour temperature.
2. Full light output during the whole burning life (no loss of light intensity).
3. The diathermic tungsten-halogen reflector absorbs part of the radiant heat.

With the reflex lighting system this ensures minimum heating of the negative. The high-intensity light of the tungsten-halogen lamp is diffused in the mixing box.

This light source and diffused illumination offer the following advantages:

1. Optimum illumination at all magnifications.
2. Reduced retouching and spotting, as the light subdues scratches, fingerprints and dust marks.
3. Softer lighting for better tone gradation.

While the advantages of diffused illumination used to be emphasised particularly for colour work, modern lighting engineering has shown that diffused illumination offers the same advantages also for black-and-white work.

For black-and-white enlargements set all filters to zero or swing them out of the light path with the white-light lever. The colour mixing head is then operative also for black-and-white papers.

3.3.2 Filter control

The CLS 605 colour mixing head uses non-fading dichroic filters that permit infinitely variable filter control over density values from 0 to 130. This subtractive colour mixing system allows the filters to be moved continuously into the light path while large illuminated scale wheels (42) in the front of the colour mixing head show the filter values set.

Note that the knob for the cyan filtration is at the left-hand side of the colour mixing head (as seen from the operator's position) while the more frequently used controls for yellow and magenta are on the right-hand side (see illumination).

3.3.3 Comparison table of Durst, Kodak and Agfa filter values

Kodak	Durst
50 yellow	= 30 yellow in colour mixing head
50 magenta	= 30 magenta in colour mixing head
50 cyan	= 30 cyan in colour mixing head

Agfa	Durst
50 yellow	= 25 yellow in colour mixing head
50 magenta	= 25 magenta in colour mixing head
50 cyan	= 25 cyan in colour mixing head

3.3.4 Supplementary filter

For high filter densities a supplementary filter can be moved into the light path by the knob (43) at the rear of the colour mixing head. This filter is equivalent to equal parts of 40 yellow and 40 magenta in the colour mixing head. It permits filter settings for negatives where even the maximum setting of 130 is insufficient.

Attention: Please take into account that for technical transport reasons the supplementary filter in the colour mixing head is engaged. This filter not being needed in normal cases, we recommend to swing it out when mounting the unit.

3.3.5 Ultraviolet and heat filters

An ultraviolet (UV) and heat filter (IR) are built into the colour mixing head.

3.3.6 The white-light lever

An important aid for sharp focusing is the white-light lever (44) which swings any selected filter setting completely out of the light path. This permits clearer and easier precision focusing.

3.3.7 The mixing box

The CLS 805 colour mixing head has two permanently fitted mixing boxes for 6×6 cm ($2\frac{1}{4} \times 2\frac{1}{4}$ inch) and 24×36 mm negatives. These boxes are moved into position with the sliding lever (45).

3.3.8 The transformer

The CLS 805 colour mixing head must always be used with the Durst COLITRA 35 transformer. For connecting the COLITRA 35 transformer see section 2.5.2.

4.0.0 Operation

4.1.0 Clean negatives

Dust and fingerprints on negatives show up disturbingly in enlargements. So before enlarging, preferably clean dirty negatives with a camel-hair or anti-static brush. Wipe off fingerprints by gently rubbing with a fluffless cloth. Remove obstinate dirt with a film cleaning fluid. Negatives must be completely dry before insertion in the negative carrier. Always clean negatives very carefully to avoid scratching the emulsion surface.

4.2.0 Centering the lamp with the SIRIOKIT BW condenser lighting unit

Before inserting the negative check for even illumination on the baseboard. If with the enlarging lamp switched on, the baseboard lighting appears uneven, adjust the lamp by moving it up and down and rotating it in its fitting until all shadows and hot spots disappear.

4.3.0 Inserting film strips and single negatives

To insert single negatives, withdraw the negative carrier (7) from the enlarger head. Place the negative accurately over the carrier opening to utilise the whole film area. Then close the negative carrier (the film is now held securely) and insert in the enlarger head. To insert film strips, raise only the top section (8) of the carrier; it locks open in this position. Now slide in the film strip from the front. It is correctly aligned when the strip abuts the film stops (27). Move these stop pins to the front (for 24×36 mm negatives) or rear (for 6×6 cm or $2\frac{1}{4} \times 2\frac{1}{4}$ inch negatives) position according to the film size. Close the negative carrier by pressing the key (16) in the top section.

4.4.0 Setting the magnification

Now set the magnification of the enlargement by raising or lowering the enlarger head. The higher up the head, the larger the image. Move the enlarger head with the knob and crank (23).

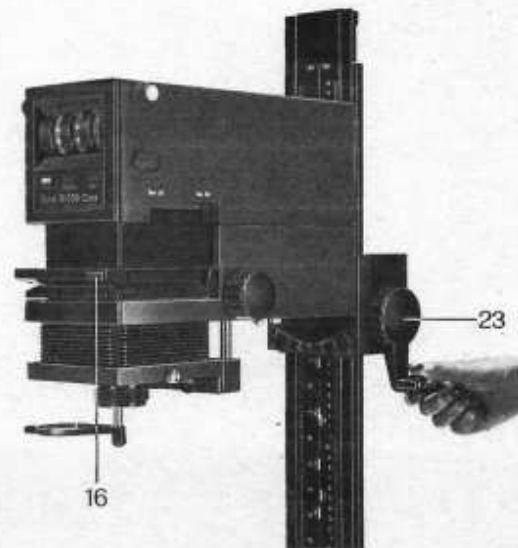
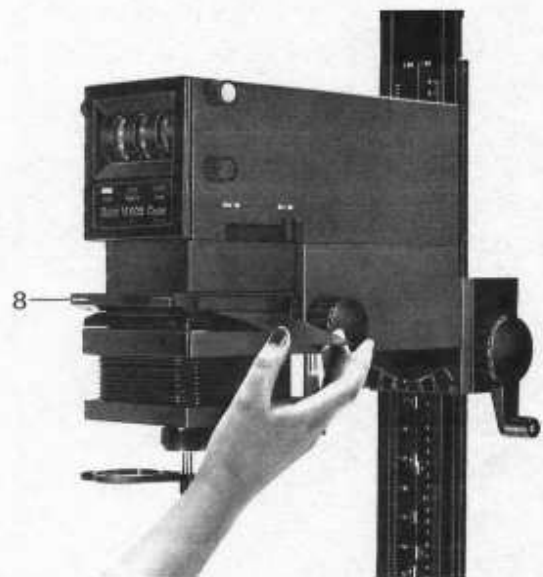
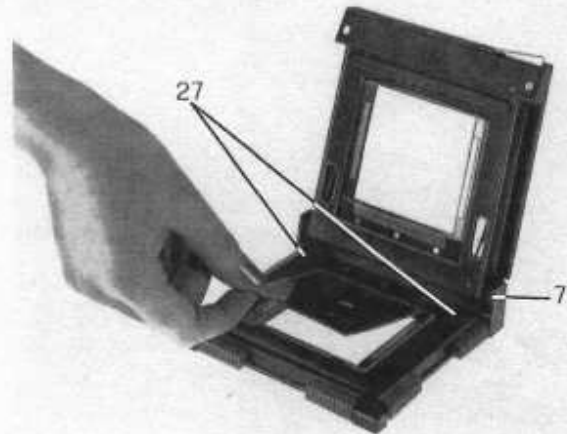

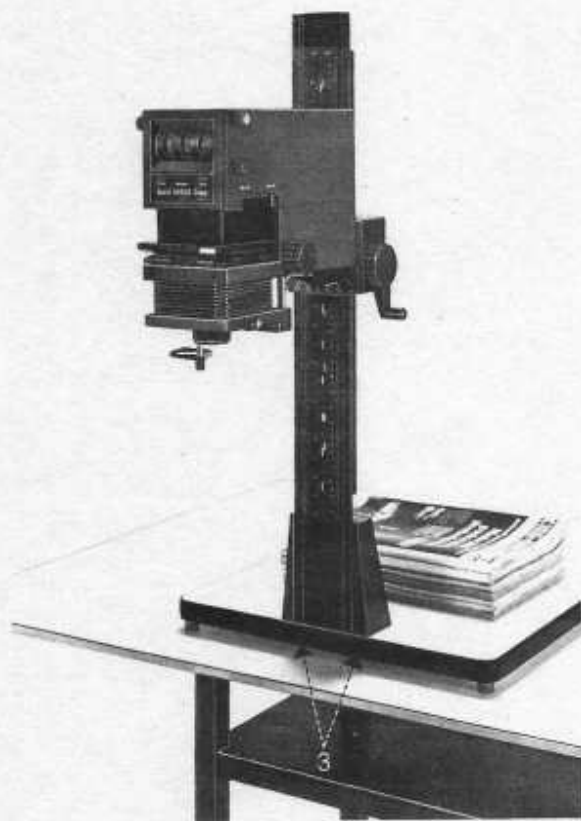

4.5.0 Focusing

Focus the image sharply (with the lens at full aperture) by turning the focusing knob (28).

Focus on the masking frame placed on the baseboard, with a sheet of white paper (not photographic paper) of the same size and thickness as the enlarging paper to be used.

Turn the focusing knob until the image projected on the baseboard appears sharpest. After focusing you may have to readjust the image size; that in turn requires a final fine focusing.

4.6.0 Exposure

After focusing and establishing the exposure time, expose the enlargement: Stop down the lens two stop values and set the exposure time on the timer. Switch to darkroom safelighting, place the enlarging paper on the baseboard or masking frame and switch on the enlarger (via the timer) for the exposure.

4.7.0 Cropping

Even expert photographers do not always manage to frame the required field of view exactly during the camera exposure. Precise framing is possible only during enlarging. This way you can often obtain several interesting enlargements from one negative or transparency. Mask down the required image area with the masking strips of the negative carrier and the sliding masks of the masking frame.

4.8.0 Giant enlargements

For big enlargements and full-size part enlargements an extension arm (24) is available separately and is mounted on the carriage shaft (6) of the basic unit. This yields maximum magnification on the baseboard.

For giant enlargements project on the floor or on the wall. For floor projection unscrew the bolts (3), turn the column base and column round through 180°, then refit the bolts (3). Stabilise the baseboard with suitable weights to stop the enlarger from tipping over. For projection on the wall slack

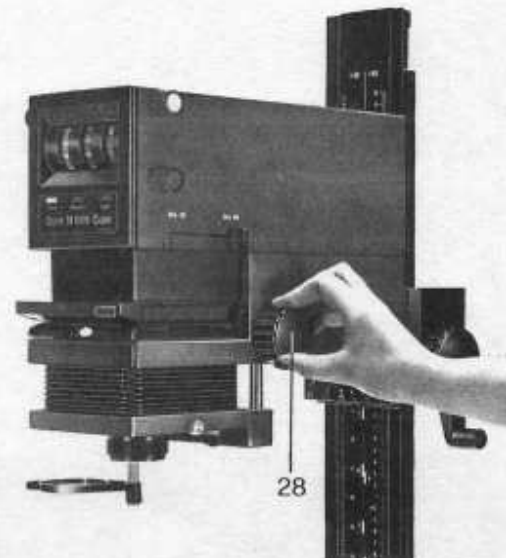
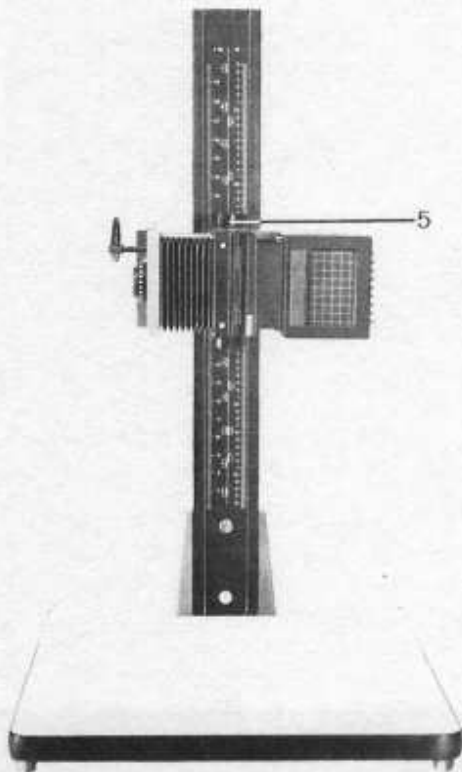

off the locking knob (5) and turn the enlarger head through 90°; it engages in this position. Then tighten the locking knob again.

4.9.0 Distortion control

Converging verticals are the result of tilting the camera when taking the picture. If for instance you shoot a high building from street level by pointing the camera up against the sky, the vertical lines will converge in the negative. Such unwanted convergence can be corrected by tilting the enlarger head (4) and the lens carrier (10). To keep the image sharp all over its area with the enlarger head tilted, stop down the lens by two stops or more to increase depth of focus.

This method of distortion control is limited by the depth of focus of the lens and the exposure variation across the image being corrected. With the enlarger head tilted, the projected image is brighter, and hence receives more exposure at one side of the paper. To compensate this, shade the brighter image area during the exposure.

5.0.0 Enlarging in colour and black-and-white

5.1.0 Colour enlargements

5.1.1 Basic requirements

Any room is suitable that can be sufficiently blacked out. As photo-chemical processes require constant temperature, preferably work in a room where the temperature remains constant between 20° and 25°C (68° and 77°F). If the room is colder, the solutions and equipment may need warming up.

The nearer the room temperature is to the process temperature, the simpler becomes constant temperature control.

Always develop colour prints in a daylight developing drum.

At first preferably keep to one make, type and even batch of paper. Changing any one of these factors distinctly affects the results. It is therefore advisable to lay in a

sufficient stock of colour paper. Keep the paper in a refrigerator (but not in the freezer compartment) until required. Apart from that, observe the paper manufacturer's instructions concerning storage. Make up the solution required for a print process the previous day and fill into brown bottles, closed air-tight with a plastic or rubber stopper.

5.1.2 Exposure and filter control

The steps of making colour enlargements start with the basic print. For this proceed as follows:

- a) Place the negative, with the emulsion side down, into the negative carrier.
- b) Move all the filters out of the light path (zero setting).
- c) Switch off the room lighting and switch on the enlarger.
- d) Select the magnification and focus the image sharply (enlarger lens at full aperture).
- e) Stop down the enlarger lens by two stops.
- f) Switch off the enlarger light. (Now you can switch on the Durst darkroom lamp with safelight.)
- g) Make a test exposure to establish the correct exposure time, using the Durst COMASK multi-print masking frame or the Durst test strip holder.

Process, rinse and dry the test strip. Then select the section that has received the correct exposure and set this time on the exposure timer.

This basic print indicates the correct exposure time, but in 99 cases out of 100 will also show a colour cast. You now have to get rid of this cast by correct filtration.

Three filter colours are available for this purpose:

1. Yellow (Y)
2. Magenta (M)
3. Cyan (C)

Before using these filters note the filter rules listed below. (More about filter effect in the booklet «Enlarge your own colour prints» available from photo dealers and from our agencies.)

Rule 1:

A colour cast in an enlargement is neutralised by a filter or filter combination of the same colour.

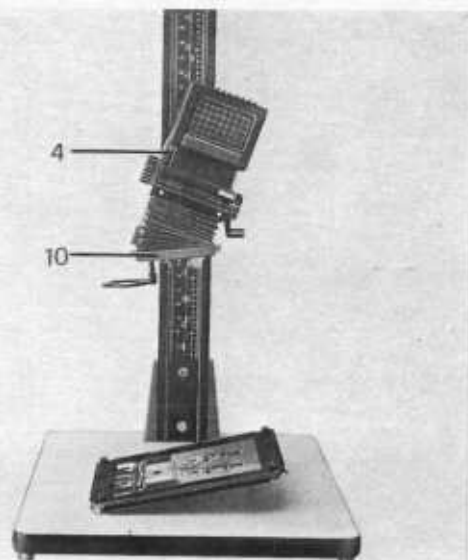
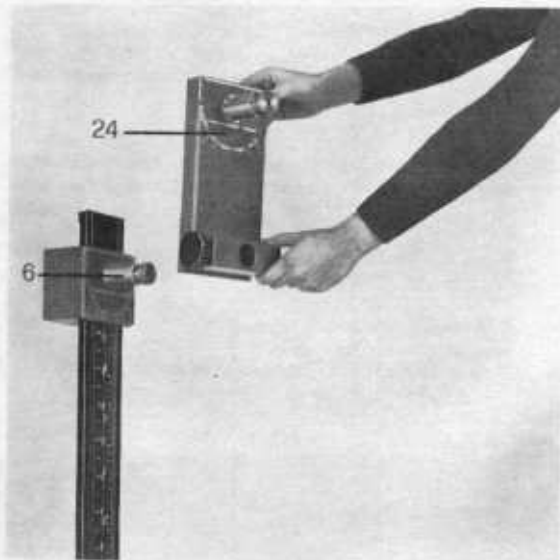

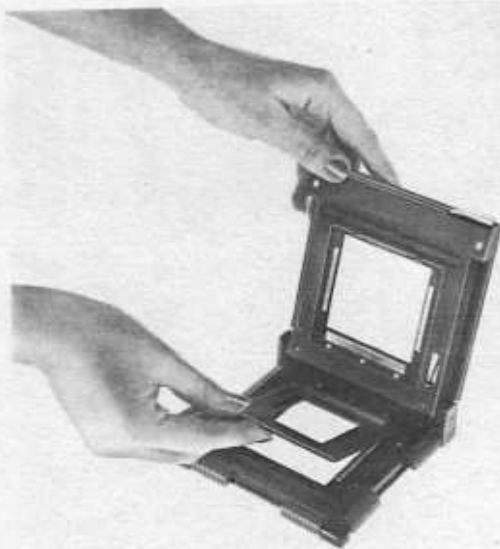

Colour cast	Filter required
Yellow	Yellow
Magenta	Magenta
Cyan	Cyan
Red	Yellow + magenta
Blue	Magenta + cyan
Green	Cyan + yellow

Rule 2:
Always use only one or two – but never three – filter colours.

Rule 3:
The stronger the colour cast, the higher must be the correcting filter value.

Rule 4:
The higher the filter value, the longer becomes the exposure time. This applies especially to the magenta and cyan filter setting.

Rule 5:
Always note the filter values, exposure time and lens aperture on the back of every test strip and every print.

Rule 6:
Preferably assess print colours by daylight or a matched daylight type source.

Notes to Rule 4
To ensure correctly exposed subsequent prints with different filter settings, the exposure time needs recalculation whenever filter settings are changed. Use the filter factors listed in the following table by substituting them in this equation:

$$T(\text{new}) = T(\text{old}) \times \frac{(F1 \times F2 \times F3) \text{ new}}{(F1 \times F2 \times F3) \text{ old}}$$

where:
 T (new) = new exposure time
 T (old) = old exposure time
 (F1 × F2 × F3) new = new filter factors
 (F1 × F2 × F3) old = old filter factors

Filter setting	Filter factors		
	Yellow	Magenta	Cyan
00	1.00	1.00	1.00
05	1.02	1.08	1.06
10	1.04	1.15	1.11
15	1.06	1.21	1.16
20	1.08	1.26	1.20
25	1.10	1.31	1.24
30	1.11	1.36	1.28
35	1.12	1.40	1.31
40	1.13	1.44	1.34
45	1.14	1.48	1.37
50	1.15	1.52	1.40
55	1.16	1.56	1.43
60	1.17	1.60	1.46
65	1.17	1.64	1.49
70	1.18	1.68	1.52
75	1.18	1.71	1.54
80	1.18	1.74	1.56
85	1.19	1.77	1.58
90	1.19	1.80	1.60
95	1.19	1.83	1.62
100	1.20	1.86	1.64
105	1.20	1.89	1.66
110	1.20	1.92	1.68
115	1.21	1.95	1.70
120	1.21	1.98	1.72
125	1.21	2.01	1.74
130	1.22	2.04	1.76

Practical examples

Example 1:

New filter settings: 20 40 00
Old filter settings: 20 10 00
If the old exposure time was 10 seconds, what is the new exposure?

Find the filter factors of the new and the old filter settings from the table and substitute them in the equation:

$$T(\text{new}) = T(\text{old}) \frac{(F1 \times F2 \times F3) \text{ new}}{(F1 \times F2 \times F3) \text{ old}} =$$
$$= 10 \times \frac{1.08 \times 1.44 \times 1.00}{1.08 \times 1.55 \times 1.00} = 12.4 \text{ seconds}$$

Example 2:

New filter settings: 20 00 00
Old filter settings: 20 10 00
If the old exposure time was 20 seconds, what is the new time?

$$T(\text{new}) = 20 \times \frac{1.08 \times 1.00 \times 1.00}{1.08 \times 1.15 \times 1.00} = 17.4 \text{ seconds}$$

One important point: Do not change the magnification until you have finished all filter tests. Make a new test strip every time you change the filter setting, until you have reached the optimum filter combination. Now make the final enlargement.

This procedure is much simpler and quicker with a colour analyser, for instance the Durst COLORNEG II.

The Durst LUXONEG exposure meter is particularly useful to find new exposure settings when you change the magnification.

5.1.3 Colour prints from transparencies

Mounted slides can be placed in the M 605 negative carrier with the SIDIA slide mask (available as an accessory). When making enlargements from transparencies, colour analysis with a colour analyser does not offer appreciable time and material savings. For with a given paper batch and a given film, filter values rarely change significantly. Use the LUXONEG density meter to establish the image density and hence exposure time.

5.1.4 Processing exposed colour prints

The results depend appreciably on the processing time, temperature and agitation. For perfect colour enlargements all these factors must remain absolutely constant. If one factor changes in the course of processing several prints, the finished picture will also differ in colour balance and contrast.

5.2.0 Black-and-white enlargements

With the Durst M 605 there are two ways of enlarging black-and-white prints:

- 1) With the black-and-white lighting unit
- 2) With the colour mixing head

For black-and-white enlargements with the colour mixing head simply set all filters to zero. The diffused light is also suitable for black-and-white enlargements. Any loss of contrast can be compensated by using a harder black-and-white paper grade. Diffused lighting has several advantages: it suppresses dust marks and scratches and yields enlargements with an extended tone range.

An important point is that the diffused lighting does not affect image sharpness. The latter depends exclusively on the negative quality and the enlarging lens.





5.3.0 Processing exposed black-and-white prints

The most convenient way is with concentrated liquid developers which are usually diluted 1:10 to 1:15 with water. Make up only as much print developer as you need at a time. Preferably do not develop more than 20 to 25 prints 18×24 cm or 8×10 inches in one litre of developer. Note the specifications given by the manufacturer of the chemicals.

If you use a plain water intermediate rinse or stop bath, replace this after every 10 prints.

The prints continue developing in the water, so the intermediate rinse should not be longer than about 30 seconds. Alternatively use a stop bath made up of 20 ml glacial acetic diluted with 1 litre of water. This immediately arrests development. Again leave the prints in this for 30 seconds.

For the fixing bath, liquid concentrates are recommended. Never process more than 20 to 25 prints 18×24 cm or 8×10 inches with one litre. The fixing bath keeps almost indefinitely, so it is useful to make up a larger amount (5 to 10 litres). Pour away used solutions.

The method for drying prints depends on the paper in use. Note that current resin or plastic coated papers must not be dried on conventional glazers. (See enclosed leaflet for details of driers.)

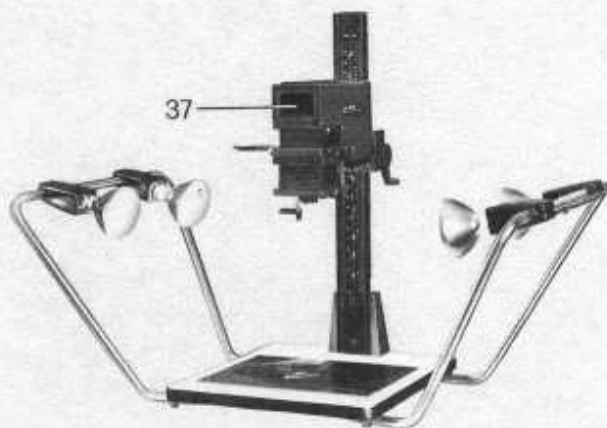

6.0.0 Copying

With the Durst M 605 you can use the copying film holder (Code: SIRIOREP) for sheet films and a suitable copying lighting system (Durst CAMFLUD).

Fit the copying film holder in place of the negative carrier in the enlarger and attach the copying lighting system to the baseboard.

When using the SIRIOKIT BW condenser lamphouse select the subject area and focus via the copying window (37) in the front of the condenser lamphouse. Previously the deflecting mirror should be reversed.

When working with the colour mixing head you can select the subject area and focus on the baseboard. For further details see the instructions for the Durst SIRIOREP copying film holder.

The M 605 can also be used as a copying stand for a normal camera. The latter is mounted on the column via the camera arm (Code: SIRIOCAM), available as an accessory.

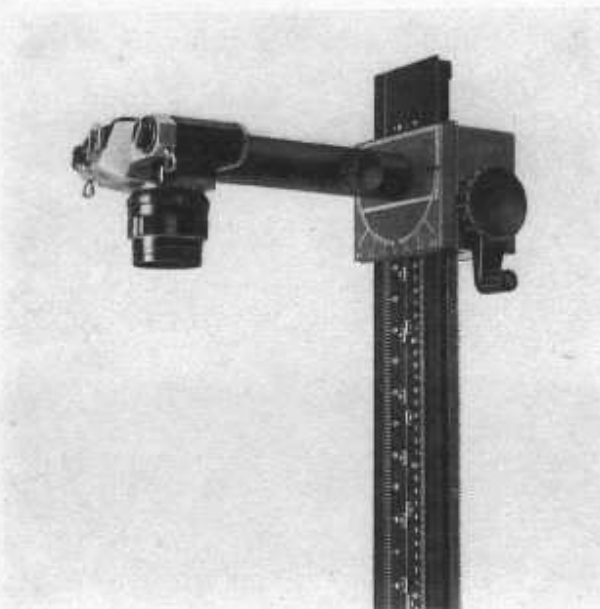

7.0.0 Maintenance

Dust is the greatest enemy in the darkroom. When you are not actually using the enlarger, preferably store it either in a closed cupboard or cover it with the SIRIOCUF dust cover. For optimum enlargements also clean the lens with a fluffless cloth before an enlarging session.

Occasionally grease the rack of the column with vaseline or mineral oil.

Durst products are being constantly developed to the latest state of the art. Illustrations and descriptions are therefore subject to modification. Please refer to the Maker's instructions for actual processing times and temperatures.



Durst Phototechnik GmbH - P.O. Box, 445 - 39100 Bolzano/Italy

Studio Durst GA 1.36/583 (a) Printed in Italy - Tezzolo/Bz

www.durst.com

Durst products are being constantly developed to the latest state of the art. Illustrations and descriptions are therefore subject to modification.